

Brass Hinge - Ref. 0520

Suitable for bar and shop counters



Product features

- suitable for flush wooden counters

Technical data

Property	Value
Load capacity	10.0 kg
Overall length	44.5 mm
Overall width	114.0 mm
Material thickness	4.0 mm
Screw	10.0 x 32.0 mm

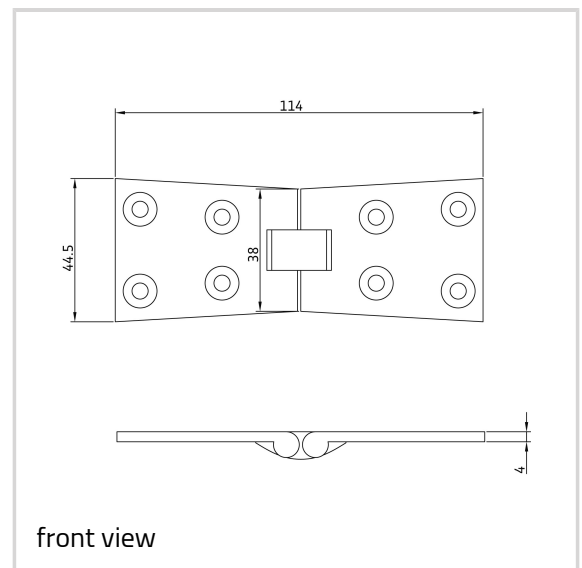

Notes

Supplied complete with pozi/slotted head brass woodscrew if required.

Item versions

Finish	Aged Brass (UK 501)
OF-No.	UK 501

Brass Hinges - Brass Hinge - Ref. 0520

VPE	10 pcs
DIN	DIN right and left hand
Article number	0520
Finish	Antique Brass (UK 502)
OF-No.	UK 502
VPE	10 pcs
DIN	DIN right and left hand
Article number	0520
Finish	Antique nickel (UK 503)
OF-No.	UK 503
VPE	10 pcs
DIN	DIN right and left hand
Article number	0520
Finish	Copper Bronze (UK 505)
OF-No.	UK 505
VPE	10 pcs
DIN	DIN right and left hand
Article number	0520
Finish	Copper (UK 506)
OF-No.	UK 506
VPE	10 pcs
DIN	DIN right and left hand
Article number	0520
Finish	Honeycombe (UK 507)
OF-No.	UK 507
VPE	10 pcs
DIN	DIN right and left hand
Article number	0520
Finish	Imitation Bronze (UK 508)
OF-No.	UK 508
VPE	10 pcs
DIN	DIN right and left hand
Article number	0520
Finish	Midnight (UK 509)
OF-No.	UK 509
VPE	10 pcs
DIN	DIN right and left hand
Article number	0520

Brass Hinges - Brass Hinge - Ref. 0520

Finish	Pearl Nickel (UK 510)
OF-No.	UK 510
VPE	10 pcs
DIN	DIN right and left hand
Article number	0520
Finish	Polished Chrome (UK 511)
OF-No.	UK 511
VPE	10 pcs
DIN	DIN right and left hand
Article number	0520
Finish	Polished & Lacquered (UK 512)
OF-No.	UK 512
VPE	10 pcs
DIN	DIN right and left hand
Article number	0520
Finish	Polished Nickel (UK 513)
OF-No.	UK 513
VPE	10 pcs
DIN	DIN right and left hand
Article number	0520
Finish	Satin Brass & Lacquered (UK 514)
OF-No.	UK 514
VPE	10 pcs
DIN	DIN right and left hand
Article number	0520
Finish	Satin Chrome (UK 515)
OF-No.	UK 515
VPE	10 pcs
DIN	DIN right and left hand
Article number	0520
Finish	Satin nickel (UK 516)
OF-No.	UK 516
VPE	10 pcs
DIN	DIN right and left hand
Article number	0520